

drabert

simply.smart.solutions.

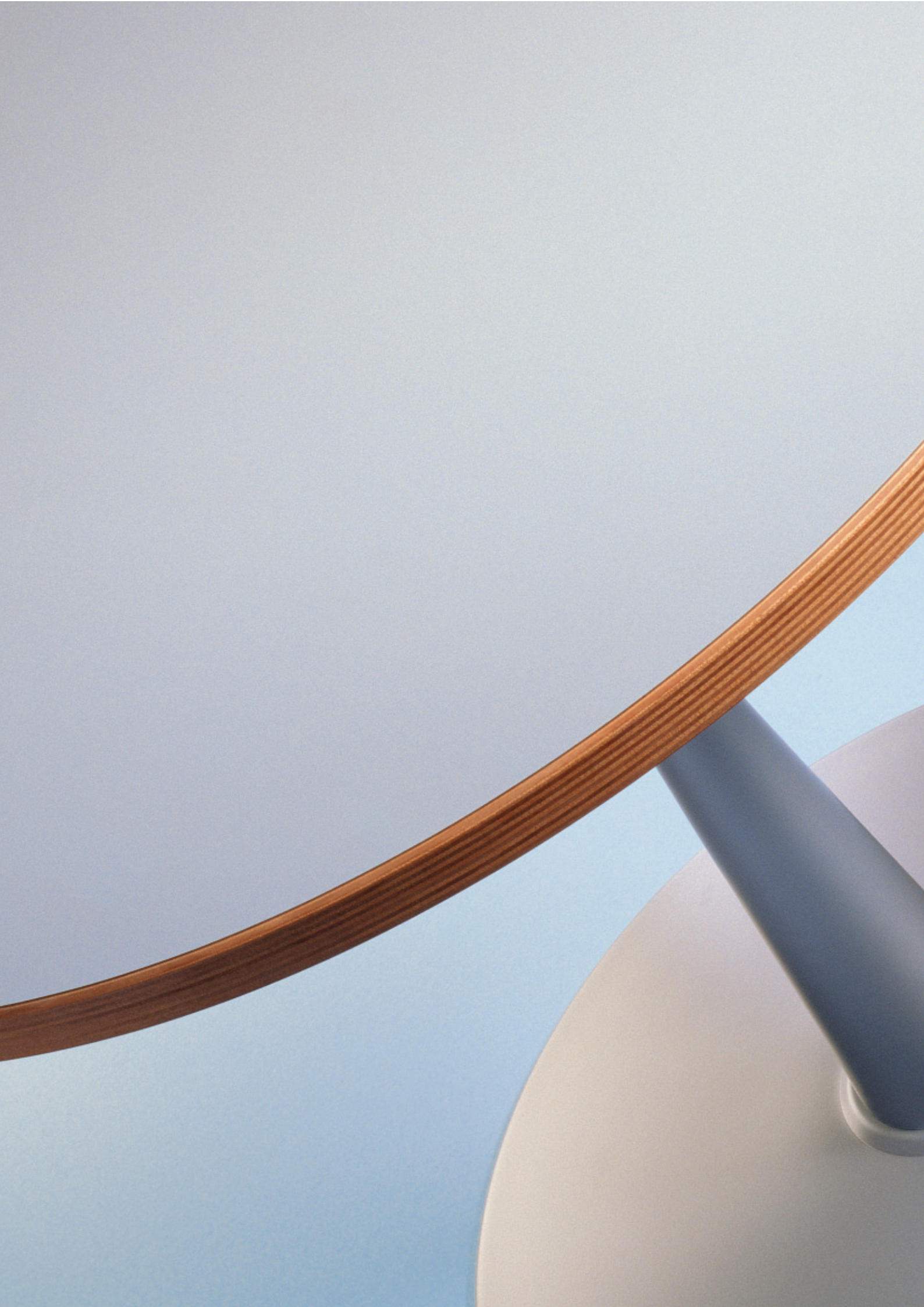

seminario cafeteria drabert



# Tischprogramm für Kantine und Cafeteria

## Materialien

Säule:

Stahlrohr  $\phi = 5,2$  cm  
mit konischem Ansatz

$\phi = 5,2$  cm /  $\phi = 10,7$  cm,

Tellerfuß  $\phi = 68$  cm.

Pulverbeschichtet

graphitschwarz oder  
aluminium natur.

Optional:

Säule und Tellerfuß  
verchromt.

Tischplatten:

Trägermaterial Mehrschicht,

HPL beschichtet,

echtholz furniert oder

linoleumbelegt.



Design: Daniel Figueroa

Stühle:  
seminario F3  
seminario dos FL3





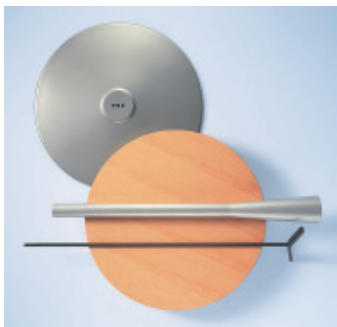

Zerlegbarer Stehtisch:  
Tischplatte, Säule und Tellerfuß  
werden durch eine Führungsstange  
miteinander verbunden und mit einer  
Flügelmutter unter dem Tellerfuß  
gesichert. Zerlegt können zehn Tische  
auf einem Stapelwagen deponiert und  
transportiert werden.



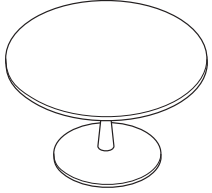

∅ = 120 cm

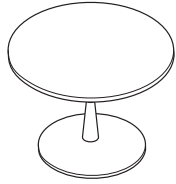

∅ = 100 cm

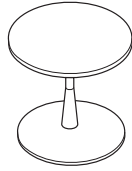

∅ = 75 cm



∅ = 75 cm

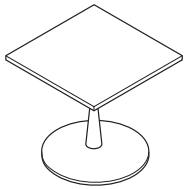

75/75 cm

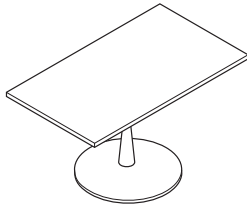

75/130 cm

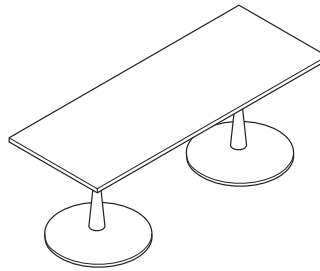

75/195 cm

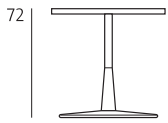

72

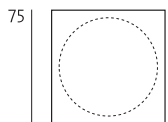
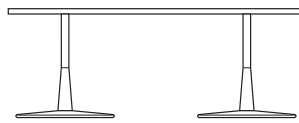

75

75

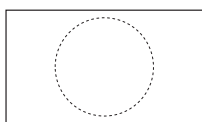

130

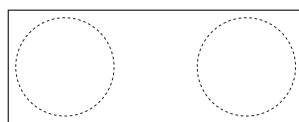

195



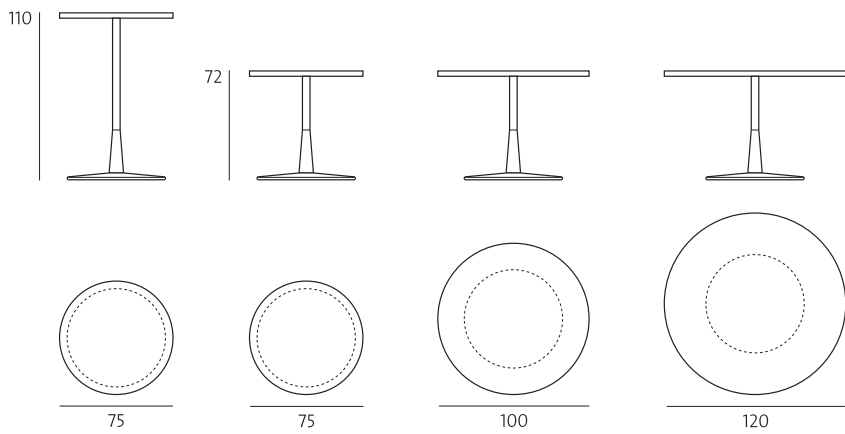

<b>Produktkennzeichen</b>	<b>Grundauführung</b>	<b>Materialien/Oberflächen</b>	<b>Optionen</b>
<b>Tellerfuß</b>	Stahl $\varnothing = 68$ cm	pulverbeschichtet graphitschwarz pulverbeschichtet aluminium natur	verchromt
<b>Mittelsäule</b>	Stahlrohr $\varnothing = 5,2$ cm mit konischem Ansatz $\varnothing = 5,2$ cm/ $\varnothing = 10,7$ cm	pulverbeschichtet graphitschwarz pulverbeschichtet aluminium natur	verchromt
<b>Tischplatten</b>	Tischplattenstärke = 3 cm Trägermaterial: Mehrschicht	HPL beschichtet echtholzfurniert linoleumbelegt	



**Gestaltung:**  
Andreas Radde, Hannover  
**Lithografie:**  
Martina Seiler, Seiler-Picture, Lehrte



5900723 OE/10.05/5.  
Technische Änderungen vorbehalten.



Drabert GmbH  
Cammer Straße 17  
D 32423 Minden

Telefon  
+49.(0)571.3850.0

Telefax Verkauf  
+49.(0)571.3850.231

Telefax Marketing  
+49.(0)571.3850.218

E-Mail  
kontakt@drabert.de  
kontakt@mikromotiv.com

www.drabert.de  
www.mikromotiv.com